

Keypad locks operate by entry of a 4-digit code. In shared use functionality, the user chooses any available locker and enters a self-selected code to lock and unlock. Once unlocked, the locker is available for a different user. Management staff operates the lock with either the Programming Key unique to the lock system or any registered Manager Bypass Key.

Lock Parts

Front Unit

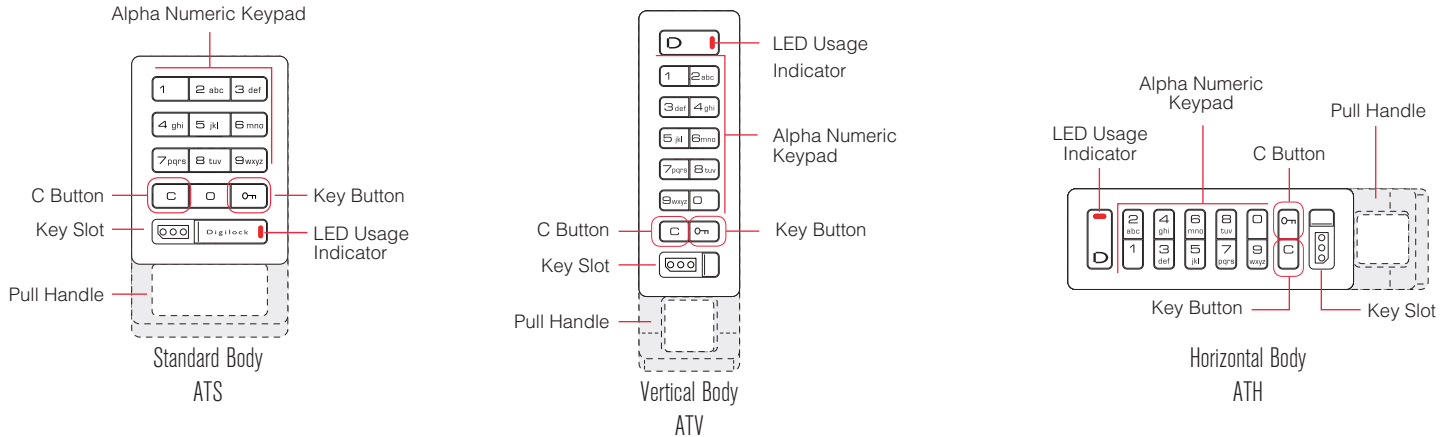

Rear Unit

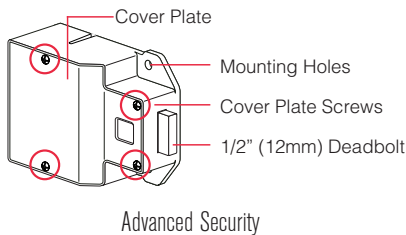

Keys

Programming Key



- Registers Manager Bypass Keys
- Provides lock access in case of forgotten/lost user credential (code or key)
- Allows management audit/inspection
- Provides external power in case of battery failure
- 1 Programming Key required per lock system

Manager Bypass Key



- Provides lock access in case of forgotten/lost user credential (code or key)
- Allows management audit/inspection
- Provides external power in case of battery failure
- Up to 25 Manager Bypass Keys may be registered per lock

User Key



- Operates the lock instead of User Code
- ADA compliant*

*US Access Board requires 5% of all locks to be ADA compliant.

Key Insertion

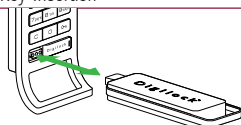

Standard Body

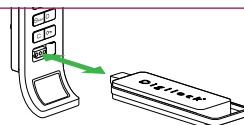

Vertical Body

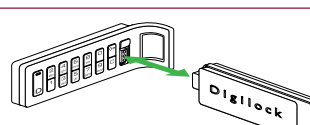

Horizontal Body

Digilock logo must face up on standard and vertical body locks.

Digilock logo must face left on horizontal body locks.

Programming Instructions

Initial Setup

New locks operate only with **[C]** **[0m]**. Locks must be setup to allow full operation.

- Touch the Programming Key to the key slot until a two-tone beep is heard and the LED turns on.
- Touch each Manager Bypass Key to the key slot. A two-tone beep will be heard for each Manager Bypass Key that is successfully registered.
- Touch the Programming Key to the key slot until a two-tone beep is heard and the LED turns off.
- Repeat above steps for each lock or follow Express Register instructions to setup all locks.

Express Register

Manager Bypass Key(s) can be quickly registered to multiple locks. The Programming Key copies the registered Manager Bypass Key(s) from one lock to multiple locks.

- Go to the lock registered with the Manager Bypass Key(s).
- Press **[C]** **[0m]** **[6][6]** **[0m]**. The LED will start to flash.
- Touch the Programming Key to the key slot until a two-tone beep is heard and the LED turns off.
- At each lock to be registered, touch the Programming Key to the key slot until a two-tone beep is heard and the LED flashes once to indicate successful registration.

Register/Add Manager Bypass Key(s)

Up to 25 Manager Bypass Keys may be registered to a lock. If required, contact your Digilock Product Representative to order additional Manager Bypass Key(s).

- Go to a lock requiring Manager Bypass Key(s).
- Press **[C]** **[0m]** **[5][5]** **[0m]**. The LED will start to flash.
- Touch the Programming Key to the key slot until a two-tone beep is heard and the LED turns on.
- Touch each Manager Bypass Key to the key slot. A two-tone beep will be heard for each Manager Bypass Key that is successfully registered.
- Touch the Programming Key to the key slot until a two-tone beep is heard and the LED turns off.
- Repeat above steps for each lock or follow Express Register instructions to register the same Manager Bypass Key(s) to multiple locks.

For Lost or Stolen Keys

For a lost or stolen Programming Key:

To prevent the lost/stolen Programming Key from operating the locks, immediately order a Replacement Programming Key from your Digilock Product Representative. Once received, follow enclosed instructions to set up the lock(s) to operate with the Replacement Programming Key.

For a lost or stolen Manager Bypass Key(s):

To prevent the lost/stolen Manager Bypass Key(s) from operating the lock(s), erase all registered Manager Bypass Key(s) and register only the remaining Manager Bypass Key(s).

- Collect all remaining Manager Bypass Key(s).
- Press **[C]** **[0m]** **[5][5]** **[0m]**. The LED will start to flash.
- Touch the Programming Key to the key slot until a two tone beep is heard and the LED turns on.
- Touch the Programming Key to the key slot again until three sets of two-tone beeps are heard and the LED turns off. All previously registered Manager Bypass Key(s) have been erased from the lock.
- Follow Register/Add Manager Bypass Key(s) instructions to register the remaining Manager Bypass Key(s).

Auto Unlock and LED Usage Indicator

Locks can be programmed to auto unlock after a set amount of hours and to have the LED flash or not flash while the lock is in use. The default setting is OFF for Auto Unlock (does not auto unlock) and ON for LED Usage Indicator (flashes while in use).

To turn on Auto Unlock (unlock after a set number of hours):

- Press **[C]** **[0m]** then touch the Manager Bypass Key to the key slot until a two-tone beep is heard and the LED turns on.
- Set the amount of hours: Press **[1]** - **[8]**. A two-tone beep will be heard and the LED will turn off.
(amount of hours)
For example: **[7]** sets the lock to auto unlock after 7 hours.
- Repeat above steps for each lock.

To turn off the LED Usage Indicator:

- Press **[C]** **[0m]** then touch the Manager Bypass Key to the key slot until a two-tone beep is heard and the LED turns on.
- Press **[0]**. A two-tone beep will be heard and the LED will turn off.
- Repeat above steps for each lock.

To turn off Auto Unlock and turn on LED Usage Indicator (Default Setting):

- Press **[C]** **[0m]** then touch the Manager Bypass Key to the key slot until a two-tone beep is heard and the LED turns on.
- Press **[9]**. A two-tone beep will be heard and the LED will turn off.
- Repeat above steps for each lock.

Operating Instructions

Operate with any User Code:

- To lock: Close the door, then press **[C]** **[] [] [] []** **[0m]**
(any 4-digit code)
- To unlock: Press **[C]** **[] [] [] []** **[0m]**, then open the door.*
(the same 4-digit code)

Operate with any User Key:

- To lock: Close the door, then touch any User Key to the key slot.
- To unlock: Touch the same User Key to the key slot, then open the door.

Operate with a registered Manager Bypass Key**:

- To lock: Close the door, then touch a registered Manager Bypass Key to the key slot.
- To unlock: Touch a registered Manager Bypass Key to the key slot, then open the door.

Operate with the Programming Key**:

- To lock: Close the door, press **[C]** **[0m]**, then touch the Programming Key to the key slot.
- To unlock: Press **[C]** **[0m]**, then touch the Programming Key to the key slot.

*The lock will go into "Sleep Mode" after 3 consecutive incorrect entries.

**If a registered Manager Bypass Key or the Programming Key is used to unlock and relock, the previous User Code or User Key will continue to operate the lock.

Support

Sleep Mode

After three consecutive incorrect User Code entries to unlock, the lock will go into “Sleep Mode” for one minute and for an additional minute for each subsequent incorrect entry. The keypad is disabled while in “Sleep Mode”.

Error Condition Indicator

Locks emit feedback when an error condition exists.

10 rapid beeps:

The lock is binding which means that either door alignment or items in the locker are preventing the lock from operating. Press on the door while operating the lock. If error condition persists, contact Digilock Support for assistance.

2 sets of three beeps:

The batteries are low. Replace the batteries.

1 beep:

The lock does not recognize the User Code or Key.

Does not Unlock with the User Code or User Key

The lock does not recognize the User Code or User Key. Operate the lock with a registered Manager Bypass Key.

Does not Operate with a Manager Bypass Key

The lock does not recognize the Manager Bypass Key. Follow Register/Add Manager Bypass Key(s) instructions to register the Manager Bypass Key to the lock. For immediate access, operate with another registered Manager Bypass Key or with the Programming Key.

Does not Operate with the Programming Key

The lock does not recognize the Programming Key. Contact Digilock Support for assistance.

No Audible Feedback when is Pressed

- The lock may be in “Sleep Mode” or the batteries need to be replaced. For immediate access, operate with a registered Manager Bypass Key. Press  to test; if no audible feedback, replace the batteries.
- If error condition persists, loosen the mounting hardware and test.
- If error condition persists, remove the lock and assemble in your hand to test. If the door is locked or damage is visible, contact Digilock Support.
- If the lock functions when assembled in your hands, reinstall and test again.
- If error condition persists, contact Digilock Support.

Battery Replacement

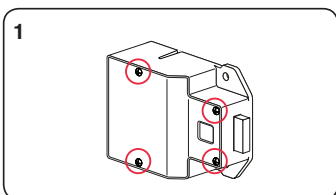

The batteries are located in the rear unit of the lock.

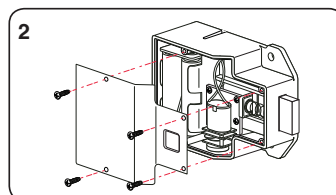

Remove the screws and the cover plate.

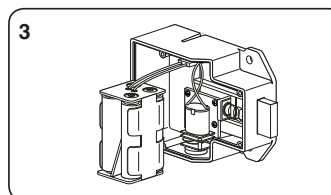

Pull the battery pack from the rear housing.
Replace with four premium alkaline AA batteries.

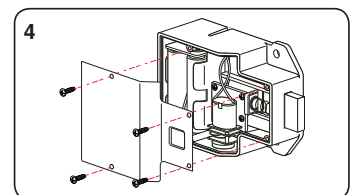

Place the battery pack back into the rear housing and screw the cover plate in place.